





1-800-BOLLARDS

The Bollard Experts

- SELECT DESIRED MATERIAL:
(8" NOMINAL SIZE)
 - FSS08000 SCH 10 STAINLESS STEEL
 - FSS08040 SCH 40 STAINLESS STEEL
 - FSS08080 SCH 80 STAINLESS STEEL
 - FCS08040 SCH 40 ASTM A-53 CARBON STEEL
 - FCS08080 SCH 80 ASTM A-53 CARBON STEEL
- SELECT DESIRED STAINLESS STEEL BOLLARD FINISH:
 - POLISHED #4 FINISH
 - AS SPECIFIED _____
- SELECT DESIRED CARBON STEEL BOLLARD FINISH:
 - POWDER COAT RAL # _____
 - AS SPECIFIED _____
- SELECT DESIRED STAINLESS STEEL BOLLARD MATERIAL:
 - TYPE 304
 - TYPE 316
- SELECT DESIRED BOLLARD CAP STYLE:
 -  DOME (SHOWN)
 -  STANDARD FLAT
 -  REVEAL
 -  SLOPED

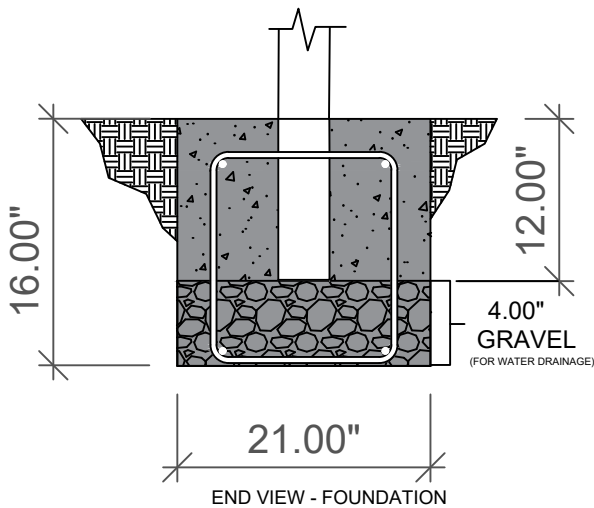

Fixed Bollard

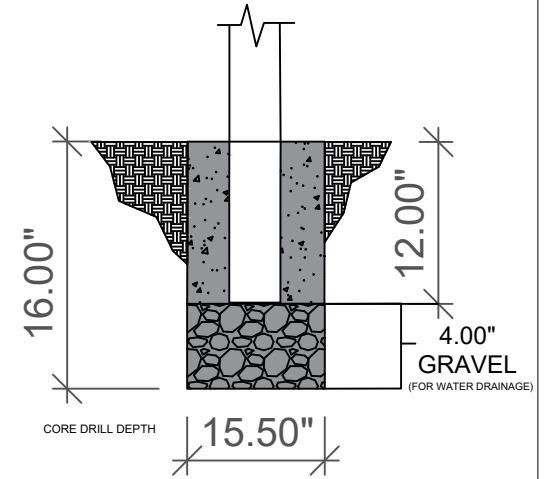
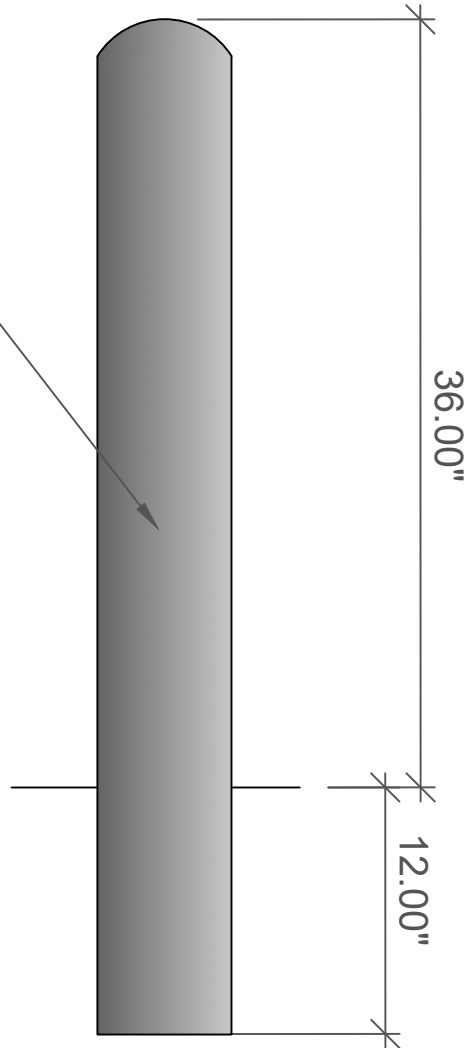

DOME (SHOWN) STANDARD FLAT REVEAL SLOPED

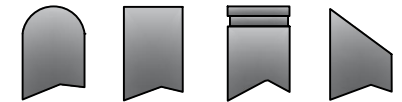

REVISIONS			
LTR	DESCRIPTION	DATE	APPVD
COMMENTS			
SPECIFICATIONS			
HEIGHT: 36"			
DIAMETER: 8.63"			
WALL THICKNESS: 0.280" SCHED 40			

APPLICATION	
NEXT ASSY	USED ON

SERIES NUMBER: XX-S060-XX	CAGE CODE: 6NGJB	REV: 6th	DRAWING NUMBER: 6th Cutsheet Size A - R1
PRODUCT FAMILY: FIXED BOLLARD	DRAWN BY: AJA	CHECKED BY:	DRAWING REV:
PRODUCT CLASS: STANDARD OR CUSTOMER DEFINED	APPROVED BY:	DATE:	SHEET: 1 OF 1
PRODUCT LINE: BOLLARD	PRODUCT SUB LINE: FIXED	TITLE: BOLLARD, FIXED	
1-800-BOLLARDS, Inc. 10 Hughes Suite A103 Irvine, CA 92618 PHONE: 1-800-BOLLARDS WEB: WWW.1800BOLLARDS.COM EMAIL: INFO@1800BOLLARDS.COM			

NOTES:
 1. INSTALLATION TO BE COMPLETED IN ACCORDANCE WITH MANUFACTURER'S SPECIFICATIONS.
 2. DO NOT SCALE DRAWING.
 3. THIS DRAWING IS INTENDED FOR USE BY ARCHITECTS, ENGINEERS, CONTRACTORS, CONSULTANTS AND DESIGN PROFESSIONALS FOR PLANNING PURPOSES ONLY. THIS DRAWING MAY NOT BE USED FOR CONSTRUCTION.
 4. ALL INFORMATION CONTAINED HEREIN WAS CURRENT AT THE TIME OF DEVELOPMENT BUT MUST BE REVIEWED AND APPROVED BY THE PRODUCT MANUFACTURER TO BE CONSIDERED ACCURATE.
 5. CONTRACTORS NOTE: FOR PRODUCT AND COMPANY INFORMATION VISIT WWW.CADMETALS.COM/IRVINE AND ENTER REFERENCE NUMBER 098427.